

VP 559x813

1. STEEL LITE FRAMES	
Type	SELF-ATTACHING & VANDAL-PROOF Design
Component	Frame A & B Tight mitered corners, no visible welds, countersunk mounting holes
Material	Steel Cold Formed Profiles, T= 1.2mm
Door Cutout	559 * 813mm (ORDER SIZE)
Frame O.D.	580 * 834mm
Screws	Sheet Metal Screws; Stainless Steel; M4*50mm (Std.) 14 pcs
2. GLASS	
Glass Size	530 * 784mm [Recommended]
Exposed Size	512 * 766mm
Glass Thk.	6.8mm, 10.8mm, 32mm (As Recommended)
3. INSTALLATION	Screws fasten the back frame to the front frame thru the door cutout;
 <ul style="list-style-type: none"> Leaving corridor side of front frame free of fasteners; Single side mounting for non-corridor exposure w/ fastening screws included; 	
4. FIRE RATING	
5. APPLICATION	Doors with Frames and Glass not only provide light to a room, they ensure safety;

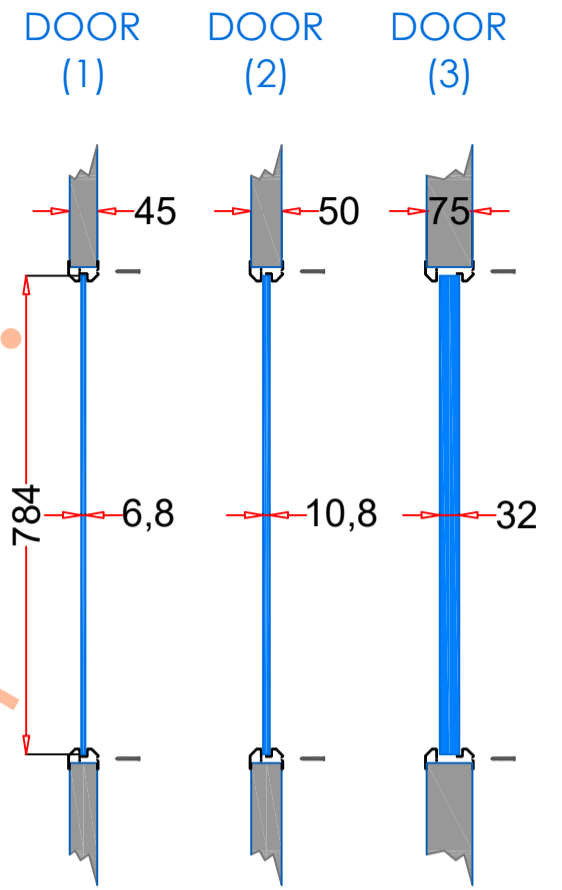

Door & Glass
[Recommend]

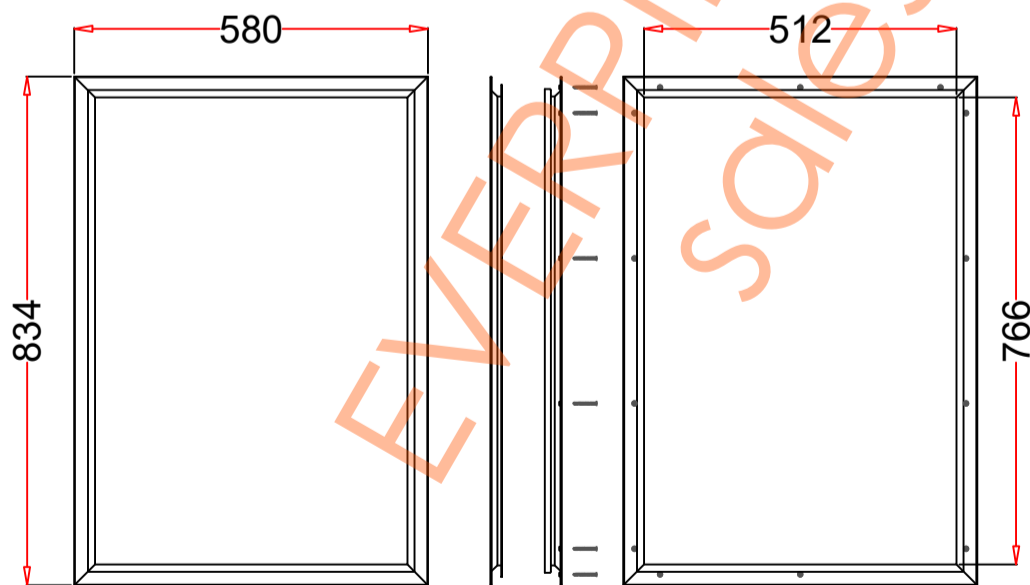

FRAME A
[to Corridor Side]

FRAME B
[Non-Corridor Side]

Frame Drawing



Door Cutout