

VP 559X762

1. STEEL LITE FRAMES	
Type	SELF-ATTACHING & VANDAL-PROOF Design
Component	Frame A & B Tight mitered corners, no visible welds, countersunk mounting holes
Material	Steel Cold Formed Profiles, T= 1.2mm
Door Cutout	559 * 762mm (ORDER SIZE)
Frame O.D.	580 * 783mm
Screws	Sheet Metal Screws; Stainless Steel; M4*50mm (Std.) 12 pcs
2. GLASS	
Glass Size	530 * 733mm [Recommended]
Exposed Size	512 * 715mm
Glass Thk.	6.8mm, 10.8mm, 32mm (As Recommended)
3. INSTALLATION	Screws fasten the back frame to the front frame thru the door cutout;
4. FIRE RATING	
5. APPLICATION	Doors with Frames and Glass not only provide light to a room, they ensure safety;

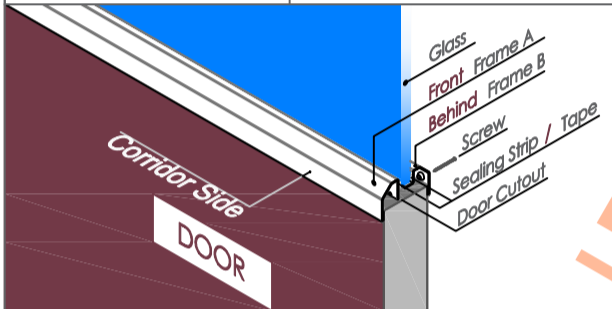

- Leaving corridor side of front frame free of fasteners;
- Single side mounting for non-corridor exposure w/ fastening screws included;

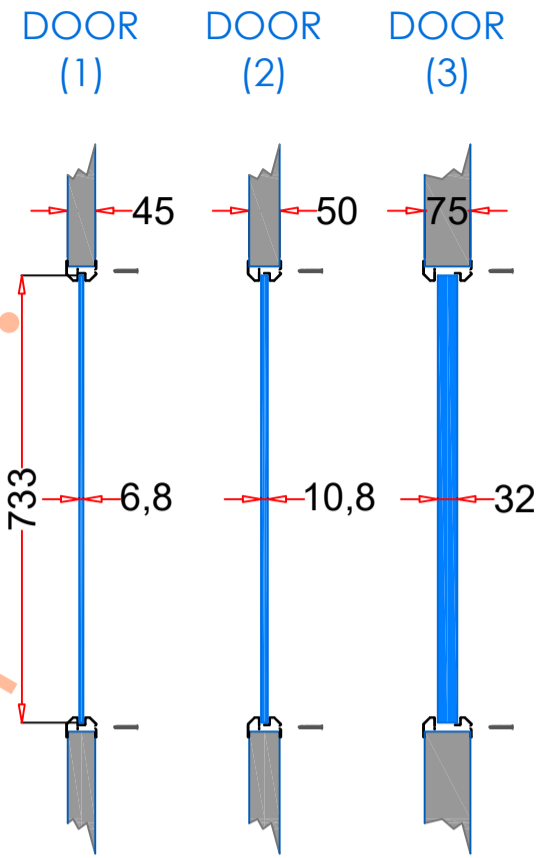

Door & Glass
[Recommend]

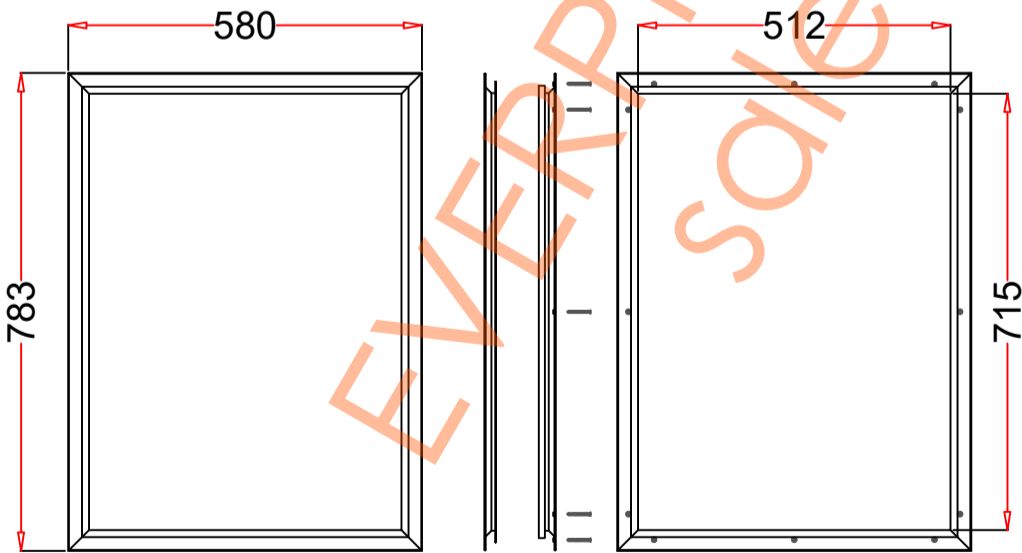

FRAME A
[to Corridor Side]

FRAME B
[Non-Corridor Side]

Frame Drawing



Door Cutout