

# VP 203X965

1. STEEL LITE FRAMES	
Type	SELF-ATTACHING & VANDAL-PROOF Design
Component	Frame A & B Tight mitered corners, no visible welds, countersunk mounting holes
Material	Steel Cold Formed Profiles, T= 1.2mm
Door Cutout	203 * 965mm ( ORDER SIZE )
Frame O.D.	224 * 986mm
Screws	Sheet Metal Screws; Stainless Steel; M4*50mm (Std.) 10 pcs
2. GLASS	
Glass Size	174 * 936mm [ Recommended ]
Exposed Size	156 * 918mm
Glass Thk.	6.8mm, 10.8mm, 32mm (As Recommended)
3. INSTALLATION	
Screws fasten the back frame to the front frame thru the door cutout;	
 <ul style="list-style-type: none"> <li>Leaving corridor side of front frame free of fasteners;</li> <li>Single side mounting for non-corridor exposure w/ fastening screws included;</li> </ul>	
4. FIRE RATING	
5. APPLICATION	
Doors with Frames and Glass not only provide light to a room, they ensure safety;	

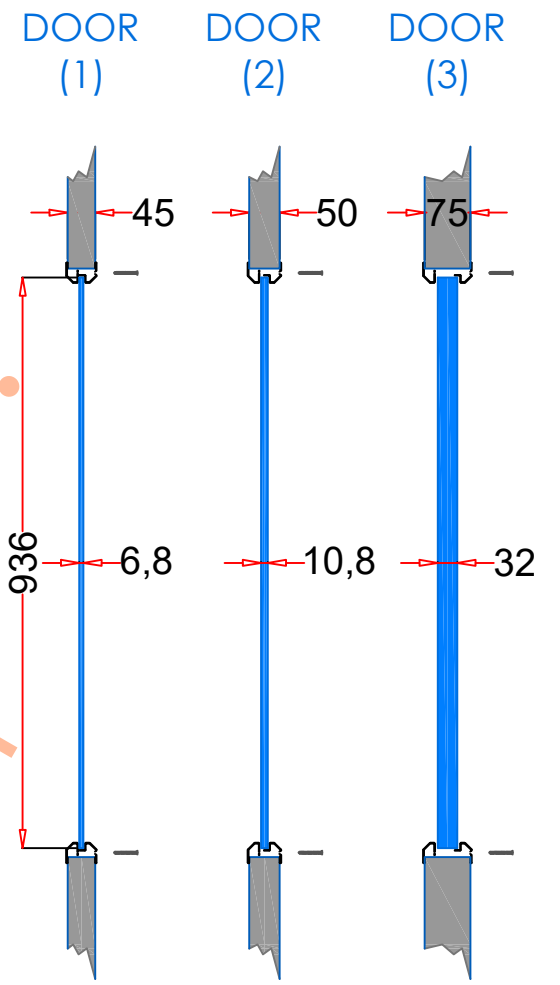

Door & Glass  
[ Recommend ]

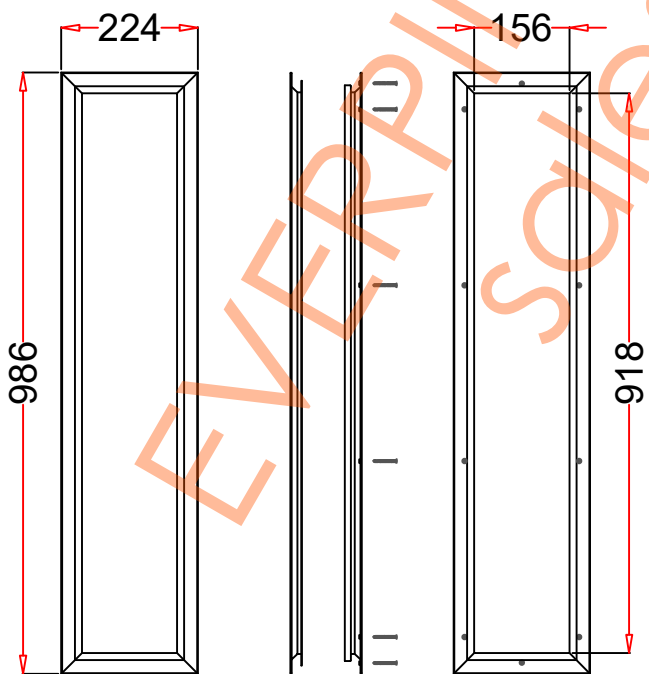

FRAME A  
[ to Corridor Side ]

FRAME B  
[ Non-Corridor Side ]



Frame Drawing

Door Cutout