

# VP 153x763

1. STEEL LITE FRAMES	
Type	SELF-ATTACHING & VANDAL-PROOF Design
Component	Frame A & B Tight mitered corners, no visible welds, countersunk mounting holes
Material	Steel Cold Formed Profiles, T= 1.2mm
Door Cutout	153 * 763mm ( ORDER SIZE )
Frame O.D.	174 * 784mm
Screws	Sheet Metal Screws; Stainless Steel; M4*50mm (Std.) 8 pcs
2. GLASS	
Glass Size	124 * 734mm [ Recommended ]
Exposed Size	106 * 716mm
Glass Thk.	6.8mm, 10.8mm, 32mm (As Recommended)
3. INSTALLATION	
Screws fasten the back frame to the front frame thru the door cutout;	
 <ul style="list-style-type: none"> <li>Leaving corridor side of front frame free of fasteners;</li> <li>Single side mounting for non-corridor exposure w/ fastening screws included;</li> </ul>	
4. FIRE RATING	
5. APPLICATION	
Doors with Frames and Glass not only provide light to a room, they ensure safety;	

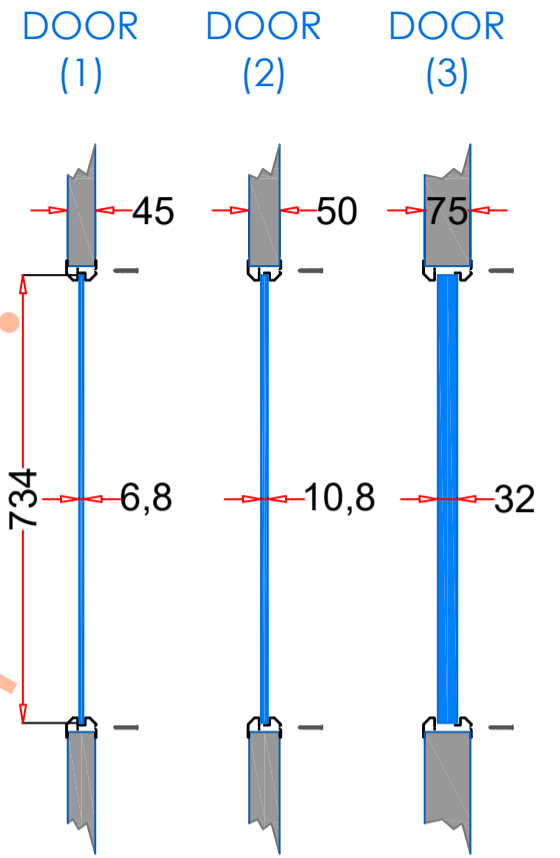

Door & Glass  
[ Recommend ]

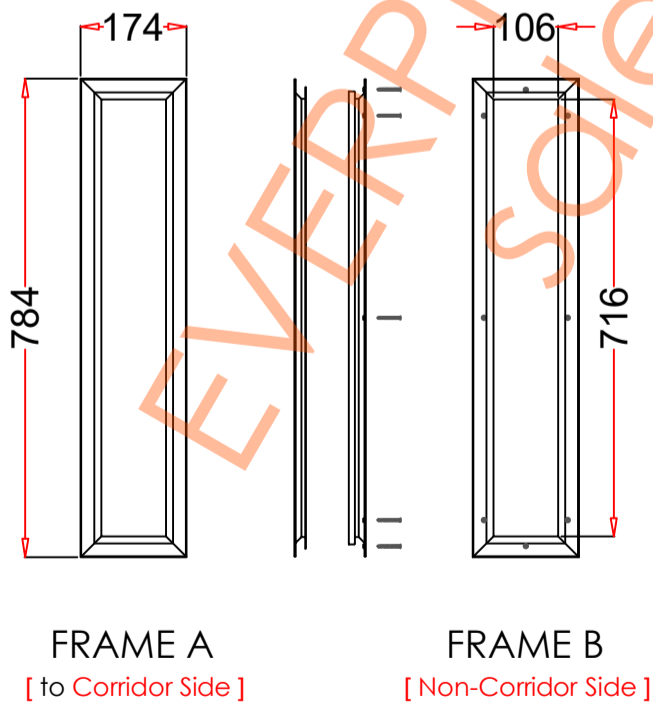

Frame Drawing



Door Cutout