

VP-C18

1. ROUND Vision Frames	
Type	SELF-ATTACHING & VANDAL-PROOF Design
Component	FRAME A & B No welds, countersunk mounting holes
Material	SPCC, 1.2mm
Door Cutout	Φ 457mm (ORDER SIZE)
Frame Overall	Φ 478mm
Screws	Sheet Metal Screws, Stainless Steel; M4*50mm (Std.) 4 pcs
2. GLASS	
Glass Size	Φ 431mm [Recommended]
Exposed Size	Φ 408mm
Glass Thk.	6.8mm, 10.8mm, 32mm (As Recommended)
3. Installation	
Screws fasten the back frame to the front frame thru the door cutout;	
 <ul style="list-style-type: none"> Leaving corridor side of front frame free of fasteners; Single side mounting for non-corridor exposure w/ fastening screws included; 	
4. FIRE RATING	
5. APPLICATION	
Doors with Frames and Glass not only provide light to a room, they ensure safety;	

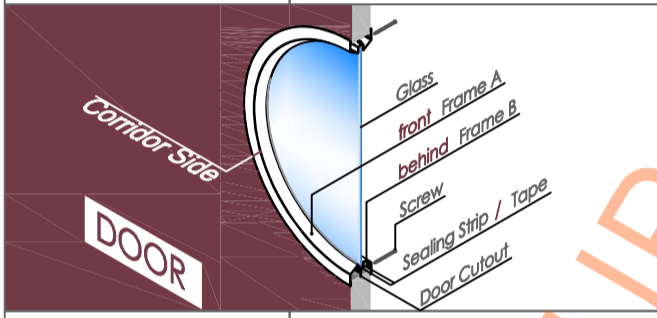

Door & Glass
[Recommend]

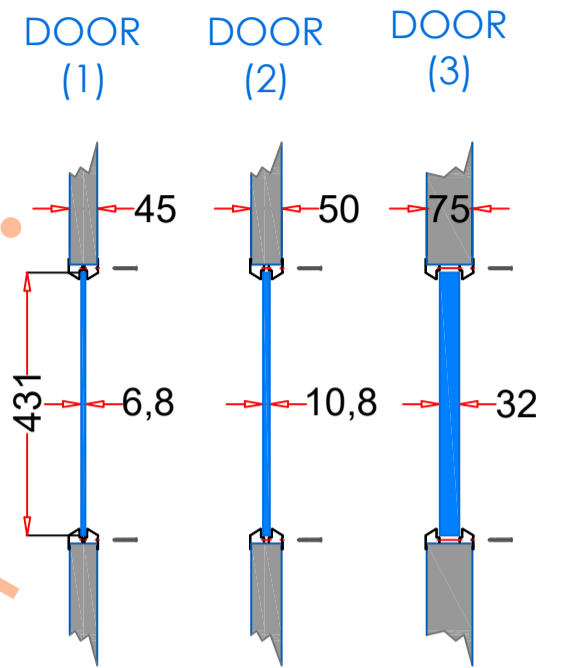
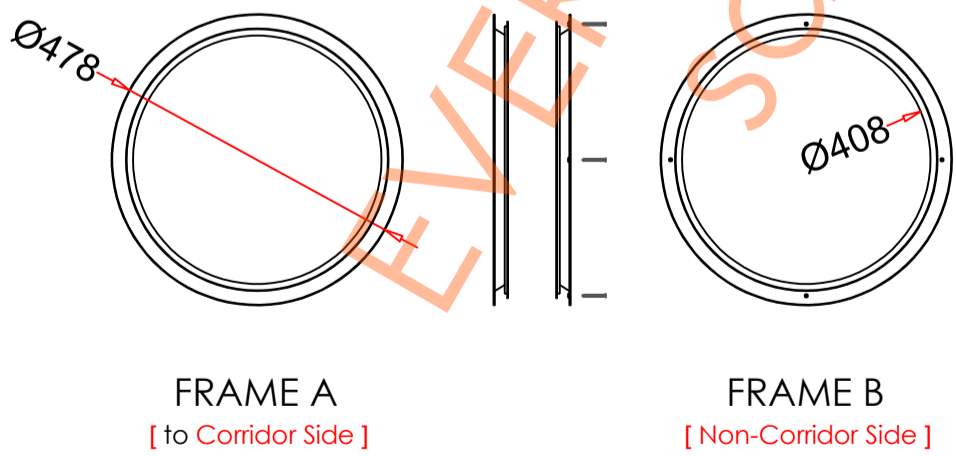

Frame Drawing

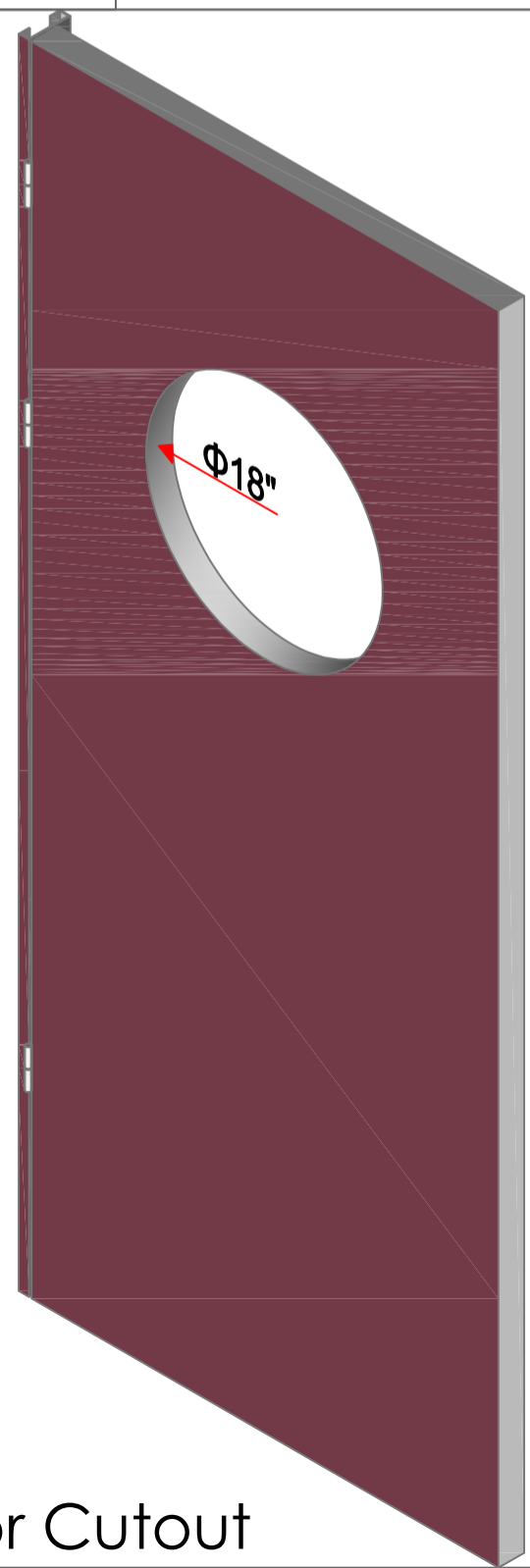

Door Cutout