

[Front]

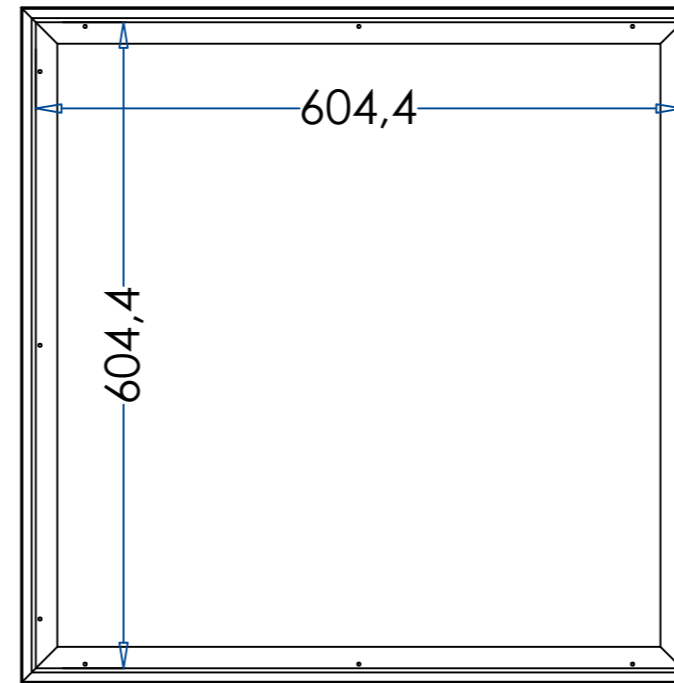

[Back]

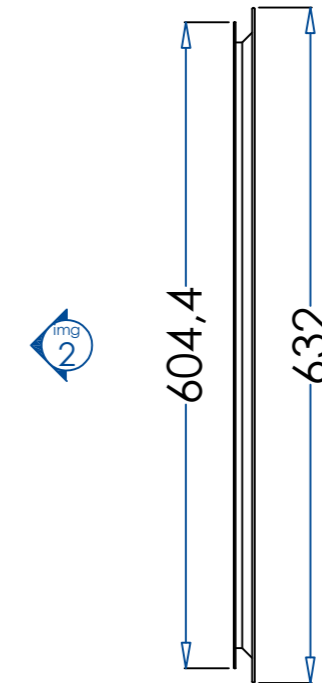

[Side]

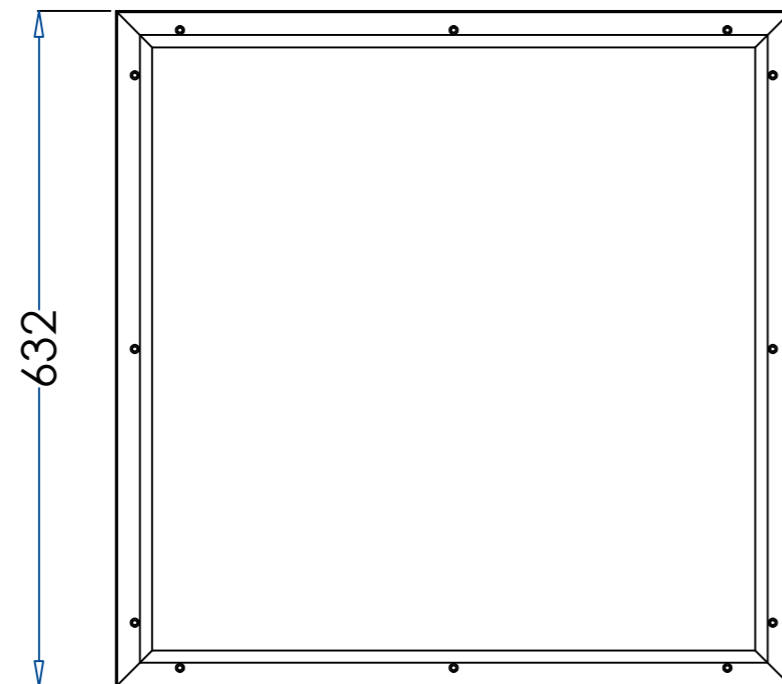

[Front]

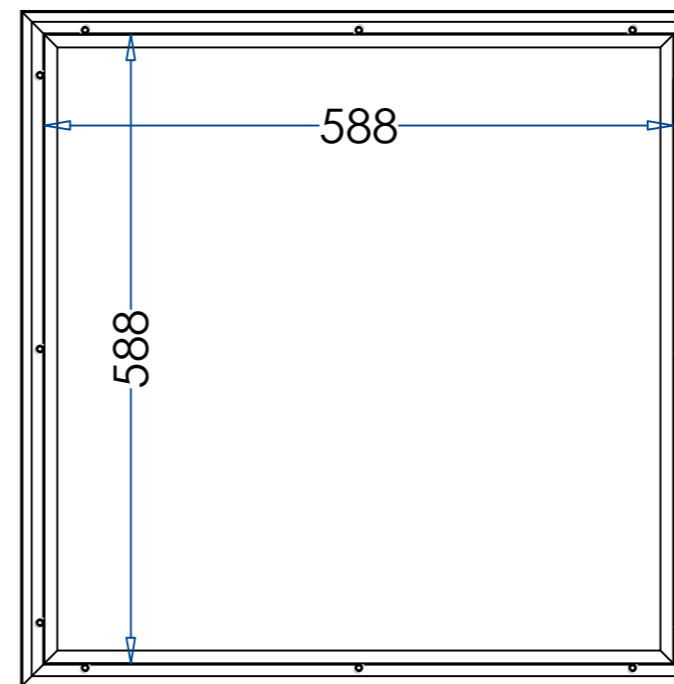

[Back]

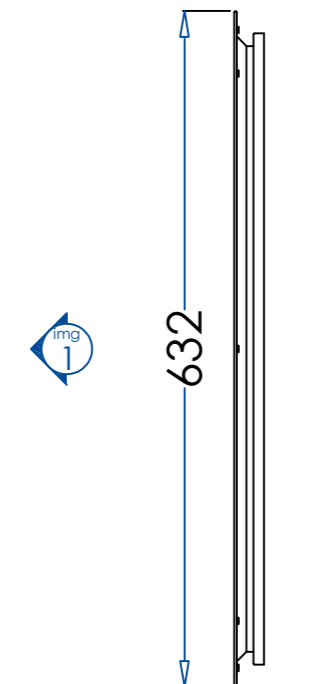

[Side]

MODEL: 24" x 24"
VP- 611 x 611
SCALE: 1 : 1

DRAWN BY: Carrie Chen
TEL: +86 18756506821

DRAWING TITLE:
VISION FRAMES

EverPine

Everpine Group Co., Ltd.
www.dLouver.com